

Nultekening badkamer

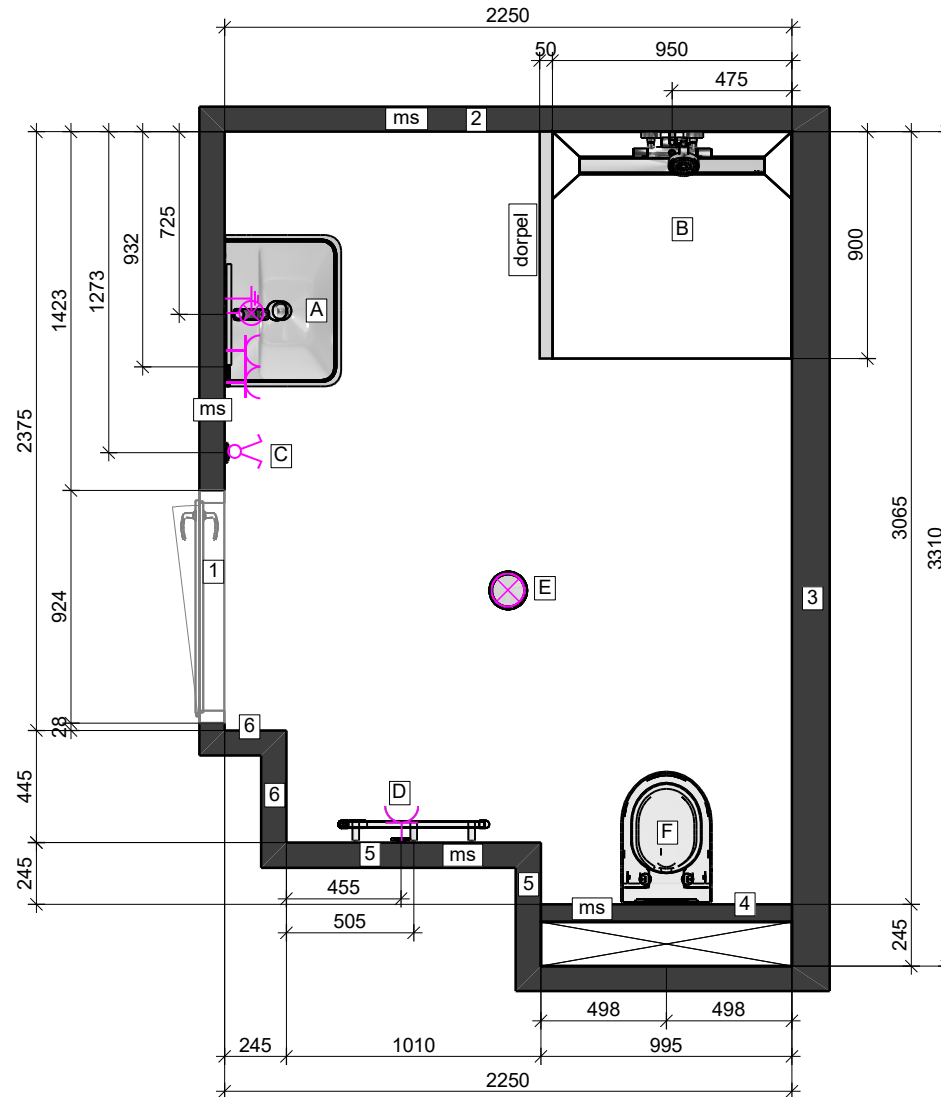

- A: wastafel met muurbuis en warm-koud water
spiegel
dubbel wcd horizontaal
wlp + cap
- B: douchemengkraan met glijstang
douchedrain WTW
dorpel gelijk aan hoogte tegelvloer
buitenzijde douchehoek 1000x900
douchehoek verdiept en op afschot
- C: dubbele lichtschakelaar
- D: e-radiator met wcd
afmeting radiator indicatief
afhankelijk van berekening
benodigd vermogen door installateur
- E: plafondlichtpunt
- F: toilet
achterwand tot plafond



Project :	Park Valley Holland Park West
Indeling:	Badkamer
Bouwnummers:	02
Referentienummer:	
Schaal:	1/30
Datum: 7-4-2026	Pagina 1

wand 3

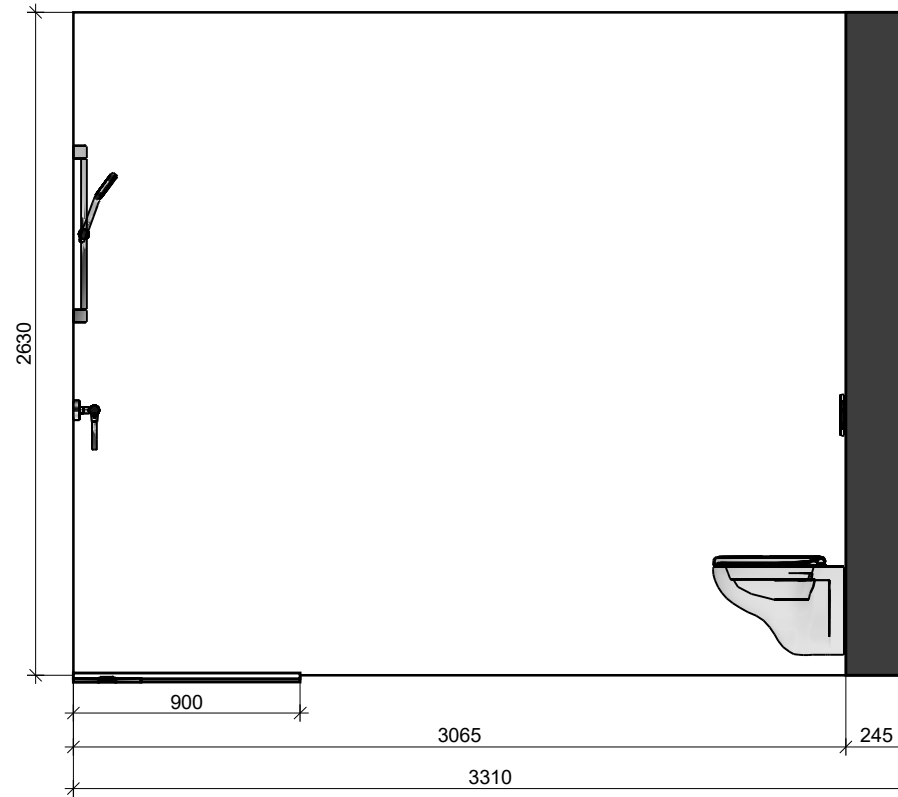

Project :	Park Valley Holland Park West
Indeling:	Badkamer
Bouwnummers:	02
Referentienummer:	
Schaal:	1/30
Datum: 7-4-2026	Pagina 2

wand 4

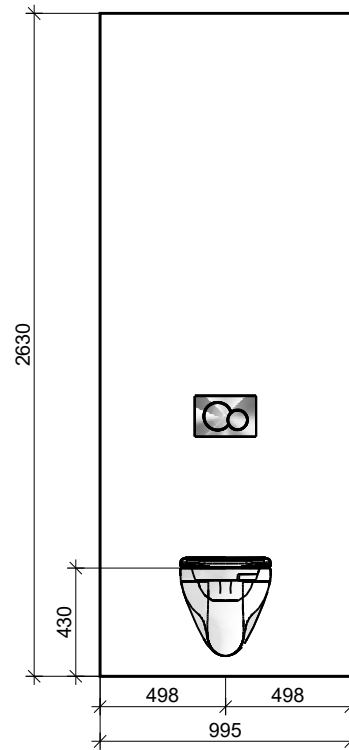

Project :	Park Valley Holland Park West
Indeling:	Badkamer
Bouwnummers:	02
Referentienummer:	
Schaal:	1/30
Datum: 7-4-2026	Pagina 3

wand 6

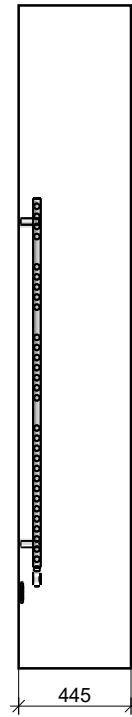

Project :	Park Valley Holland Park West
Indeling:	Badkamer
Bouwnummers:	02
Referentienummer:	
Schaal:	1/30
Datum: 7-4-2026	Pagina 4

wand 2

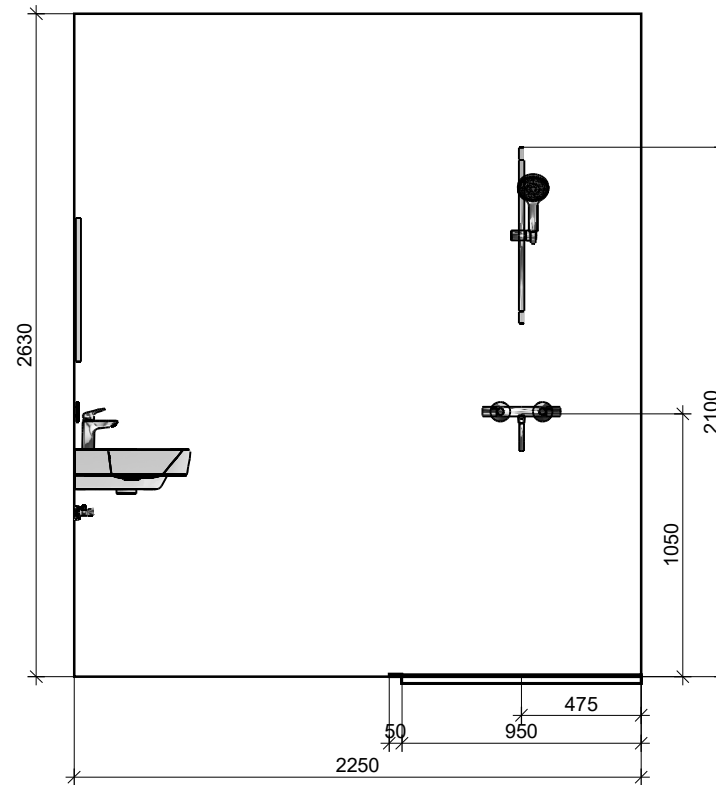

Project :	Park Valley Holland Park West
Indeling:	Badkamer
Bouwnummers:	02
Referentienummer:	
Schaal:	1/30
Datum: 7-4-2026	Pagina 5

wand 5

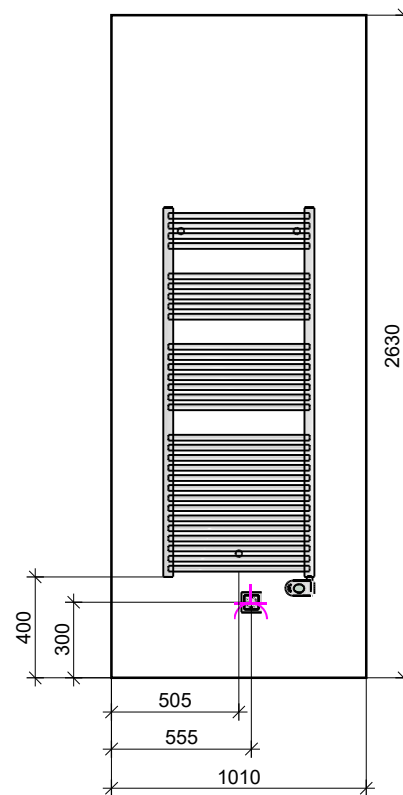

 Enkele doos



Project :	Park Valley Holland Park West
Indeling:	Badkamer
Bouwnummers:	02
Referentienummer:	
Schaal:	1/30
Datum: 7-4-2026	Pagina 6

wand1

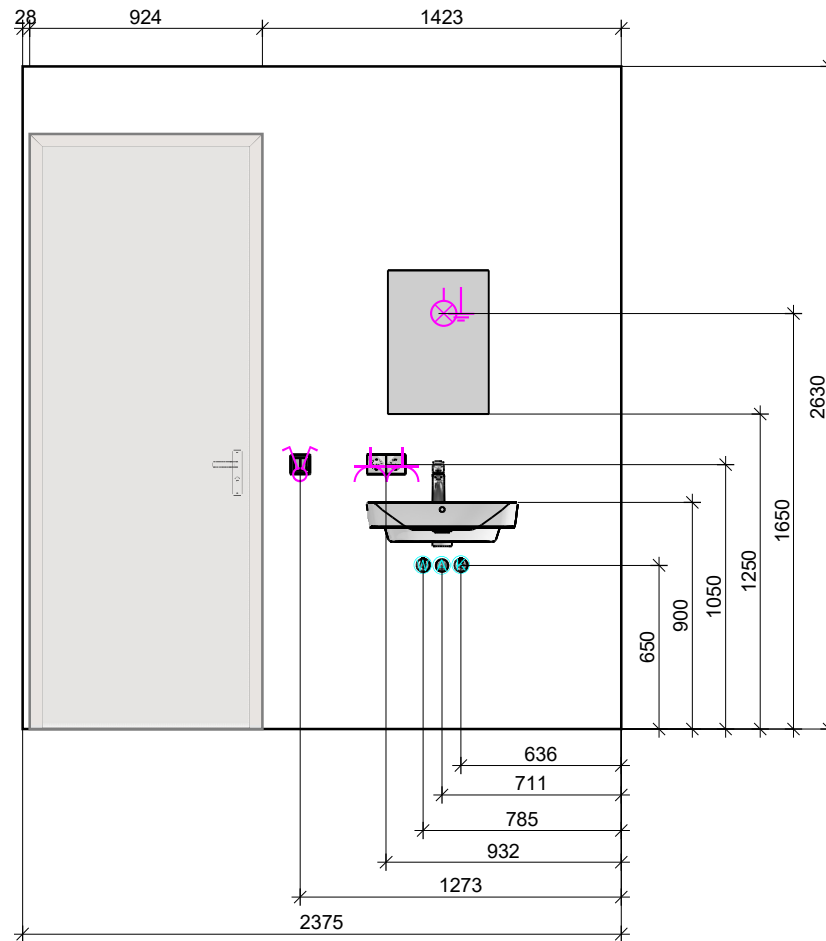

	Water-afvoer
	Water-koud
	Water-warm
	Dubbele contactdoos
	Dubbele schakelaar
	Wandlicht aansluiting
	Aarding



Project :	Park Valley Holland Park West
Indeling:	Badkamer
Bouwnummers:	02
Referentienummer:	
Schaal:	1/30
Datum: 7-4-2026	Pagina 7